

Cable-Extension Position Transducer

Precision Potentiometric Output
Ranges: 0-2 to 0-50 inches
Compact Size • OEM Applications



PT1A

Specification Summary:

GENERAL

Full Stroke Range Options 0-2 to 0-50 inches
 Output Signal Options..... voltage divider (potentiometer)
 Accuracy $\pm 0.25\%$ to $\pm 0.10\%$ full stroke *see ordering information*
 Repeatability..... $\pm 0.02\%$ full stroke
 Resolution essentially infinite
 Measuring Cable019-in. dia. nylon-coated stainless steel
 Enclosure Material..... glass-filled polycarbonate and black anodized aluminum
 Sensor plastic-hybrid precision potentiometer
 Potentiometer Cycle Life *see ordering information*
 Maximum Retraction Acceleration *see ordering information*
 Weight..... 1 lb. max.

ELECTRICAL

Input Resistance Options 500, 1K, 5K, 10K or bridge, *see ordering information*
 Power Rating, Watt *see ordering information*
 Recommended Maximum Input Voltage *see ordering information*
 Output Signal Change Over Full Stroke Range..... 94% $\pm 4\%$ of input voltage

ENVIRONMENTAL

Enclosure NEMA 4, IP 65
 Operating Temperature 0° to 200°F (-17° to 90°C)
 Vibration..... up to 10 G's to 2000 Hz maximum

Outline Drawing

Range	A
2, 10	1.04 [26,4]
5, 25, 50	0.58 [14,7]
15, 30	0.82 [20,8]
20, 40	0.74 [18,8]

inches [mm]

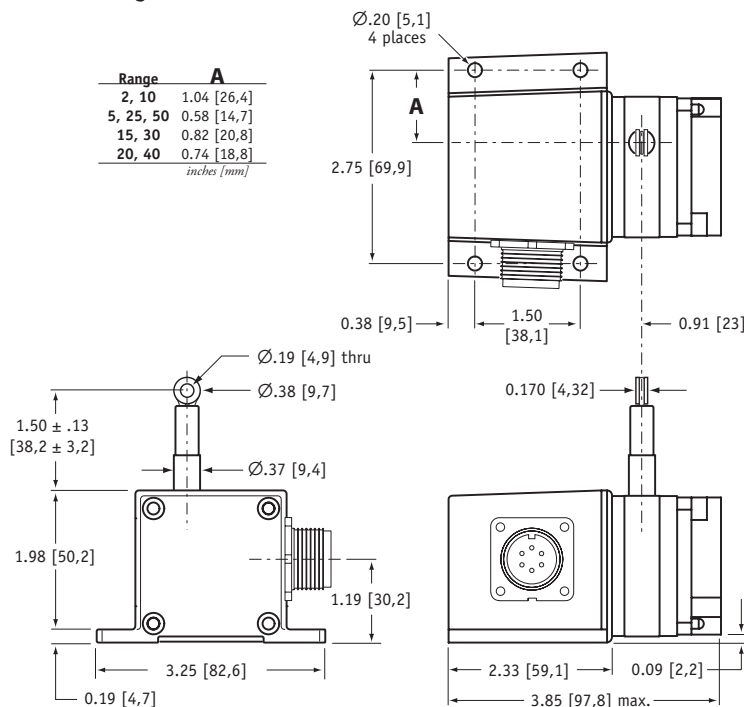

dimensions are in inches [mm], tolerances are 0.03 inches [0,8 mm]



The PT1A is perfect where space and money are limited. The PT1A is part of Celesco's compact line of cable-extension transducers. Using a high cycle plastic-hybrid potentiometer, the PT1A provides a precision voltage divider position feedback signal for full-scale measurement ranges from 2 to 50 inches.

The PT1A has many features to offer including 500 to 10K ohm potentiometer selection, adjustable bridge circuit and multiple measuring cable exit options.

Output Signal

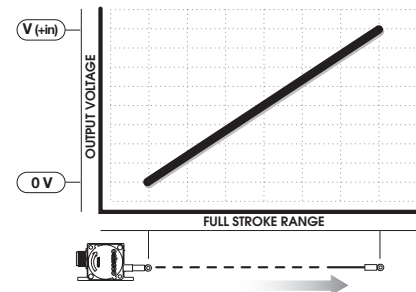

Ordering Information:

Model Number:

PT1A - - - - - -
order code: **R** **A** **B** **C** **D**

Sample Model Number:

PT1A - 30 - UP - 500 - MC4 - SG

- R** range: 30 inches
- A** measuring cable exit: up
- B** output signal: 500-ohm pot.
- C** electrical connection: 4-pin micro connector
- D** cable guide: spring-loaded guide

Full Stroke Range:

R order code:	2	5	10	15	20	25	30	40	50
full stroke range, min:	2 in.	5 in.	10 in.	15 in.	20 in.	25 in.	30 in.	40 in.	50 in.
accuracy (% of f.s.):	0.25%		0.15%			0.10%			
potentiometer cycle life:	2,500,000 cycles		500,000 cycles			250,000 cycles			
cable tension (20%):	12 oz.	5 oz.	12 oz.	9 oz.	6 oz.	5 oz.	9 oz.	6 oz.	5 oz.
maximum cable acceleration:	11 G's	3 G's	11 G's	5 G's	4 G's	3 G's	5 G's	4 G's	3 G's

Cable Exit:

A order code: **UP** **DN** **FR** **BK**
 direction: up down front back

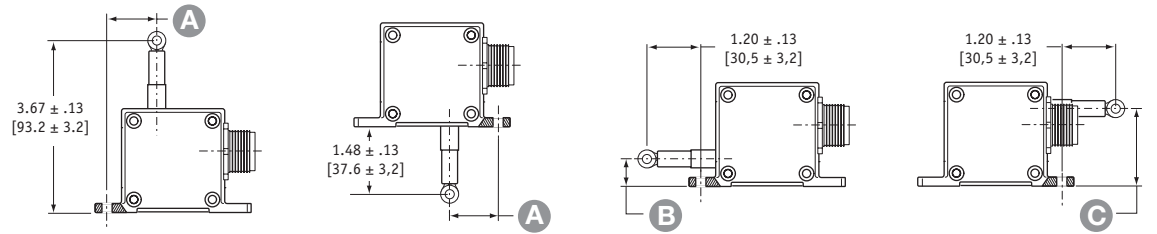

measurement range	2	5	10	15	20	25	30	40	50
A	1.04 in. 26,4 mm	0.58 in. 14,7 mm	1.04 in. 26,4 mm	0.82 in. 20,8 mm	0.74 in. 18,8 mm	0.58 in. 14,7 mm	0.82 in. 20,8 mm	0.74 in. 18,8 mm	0.58 in. 14,7 mm
B	0.75 in. 19,1 mm	0.29 in. 6,1 mm	0.75 in. 19,1 mm	0.53 in. 13,5 mm	0.45 in. 11,5 mm	0.29 in. 6,1 mm	0.53 in. 13,5 mm	0.45 in. 11,5 mm	0.29 in. 6,1 mm
C	1.43 in. 36,3 mm	1.89 in. 48,0 mm	1.43 in. 36,3 mm	1.65 in. 41,9 mm	1.73 in. 43,9 mm	1.89 in. 48,0 mm	1.65 in. 41,9 mm	1.73 in. 43,9 mm	1.89 in. 48,0 mm

Output Signals:

B order code: **500** **1K** **5K** **10K** **AB**
 500 ohm* 1000 ohm* 5000 ohm* 10,000 ohm* adjustable bridge
 (0...30 mV/V)

*tolerance = ±10%

max. input voltage and power rating, options: 500, 1K, 5K, 10K

	2-inch, 5-inch range	10-inch to 50-inch range
500-ohms:	20 V AC/DC (1 W)	30 V AC/DC (2 W)
1K to 10K-ohms:	30 V AC/DC (1 W)	30 V AC/DC (2 W)

circuit options: 500, 1K, 5K, 10K

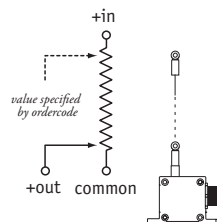

circuit option: AB (adjustable bridge)

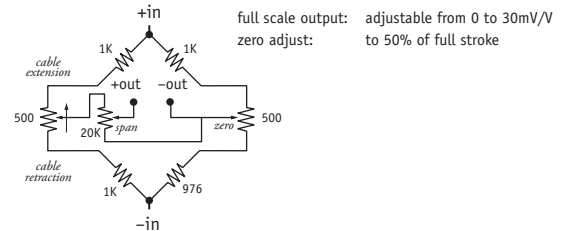

Ordering Information (cont.)

Electrical Connection:

ⓐ order code:

MC4
4-pin micro-connector
with 12 ft [3.5 M] cordset

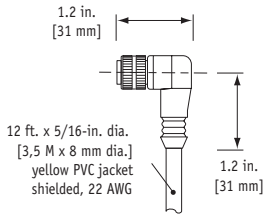

M6
6-pin plastic connector
with mating plug

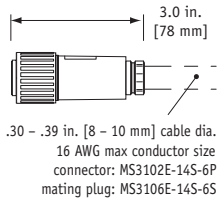

C25
25-ft. instrumentation cable
24 AWG, shielded

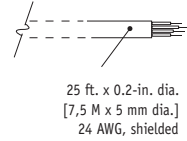

4-pin mating plug and cord set:



pin	color code	standard	bridge
1	RED-BLK TR.	+IN	+IN
2	RED-WHT TR.	COMMON	-IN
3	RED	+OUT	+OUT
4	GREEN	-	-OUT

6-pin mating plug:

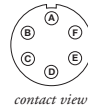

pin	standard	bridge
A	+IN	+IN
B	COMMON	-IN
C	+OUT	-OUT
D	-	+OUT

25-ft. cable:

color code	standard	bridge
RED	+IN	+IN
BLACK	COMMON	-IN
GREEN	+OUT	+OUT
WHITE	-	-OUT

Cable Guide:

ⓓ order code:

blank
standard cable guide

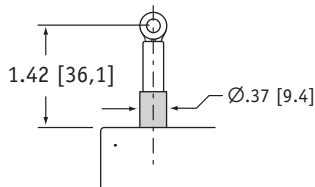

SG
spring-loaded guide

cable-guide cushions impact from accidental free release

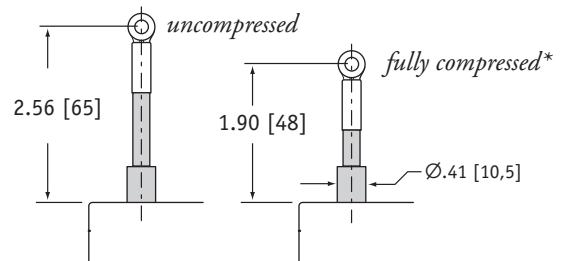

**note: start of full stroke range begins at full compression point (except 2-inch and 5-inch ranges).*