

PT9420

Heavy Industrial • 4...20mA, 0...20mA

Absolute Linear Position to 550 inches (1400 cm)

Aluminum or Stainless Steel Enclosure Options

VLS Option To Prevent Free-Release Damage

IP68 • NEMA 6 Protection • Hazardous Area Certification



GENERAL

Full Stroke Range Options (on this datasheet)	0-75 to 0-550 inches
Output Signal Options	4...20 mA (2-wire) and 0...20 mA (3-wire)
Accuracy	± 0.12% full stroke
Repeatability	± 0.05% full stroke
Resolution	essentially infinite
Measuring Cable Options	stainless steel or thermoplastic
Enclosure Material	powder-painted aluminum or 303 stainless steel
Sensor	plastic-hybrid precision potentiometer
Potentiometer Cycle Life	≥ 250,000
Maximum Retraction Acceleration	see ordering information
Maximum Velocity	see ordering information
Weight, Aluminum (Stainless Steel) Enclosure	8 lbs. (16 lbs.) max.

ELECTRICAL

Input Voltage	see ordering information
Input Current	20 mA max.
Maximum Loop Resistance (Load)	(loop supply voltage – 8)/0.020
Circuit Protection	38 mA max.
Impedance	100M ohms @ 100 VDC, min.
Output Signal, Zero Adjust	up to 50% of full stroke range
Output Signal, Span Adjust	to 50% of factory set span

ENVIRONMENTAL

Enclosure	NEMA 4/4X/6, IP 67/68
Hazardous Area Certification	see ordering information
Operating Temperature	-40° to 200°F (-40° to 90°C)
Vibration	up to 10 g to 2000 Hz maximum
Thermal Effects, Zero	0.01% f.s./°F, max.
Thermal Effects, Span	0.01%/°F, max.

EMC COMPLIANCE PER DIRECTIVE 89/336/EEC

Emission / Immunity	EN50081-2 / EN50082-2
---------------------	-----------------------

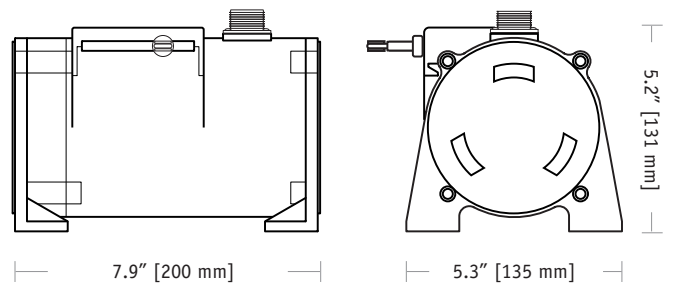
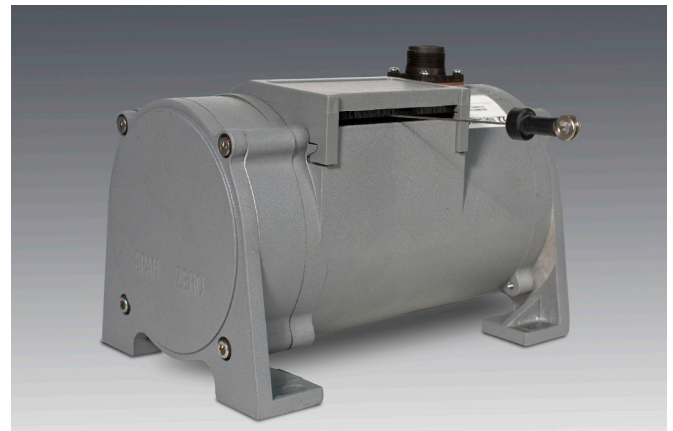

The PT9420 is a great value for demanding long-range applications requiring a 4 - 20 mA linear position feedback signal. Sealed to meet NEMA 4 standards, this Cable-Extension Transducer will perform even under the harshest of environmental conditions.

As a member of Celesco's innovative family of NEMA-4 rated cable-extension transducers, the PT9420 offers numerous benefits. It installs in minutes, functions properly without perfectly parallel alignment, and when its cable is retracted, it measures only 6".

Output Signal:

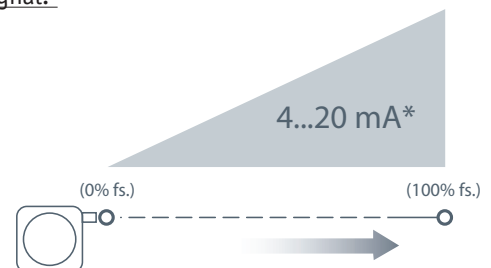

*Optional 3-wire, 0...20mA output signal available.

20630 Plummer Street • Chatsworth, CA 91311
tel: 800.423.5483 • +1.818.701.2750 • fax: +1.818.701.2799



celesco

celesco.com • info@celesco.com

Fig. 1 – Outline Drawing (18 oz. cable tension only)

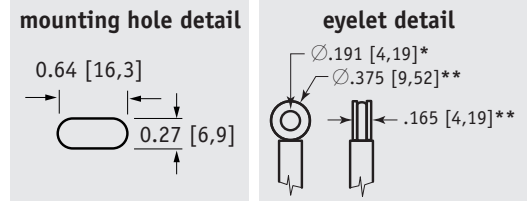
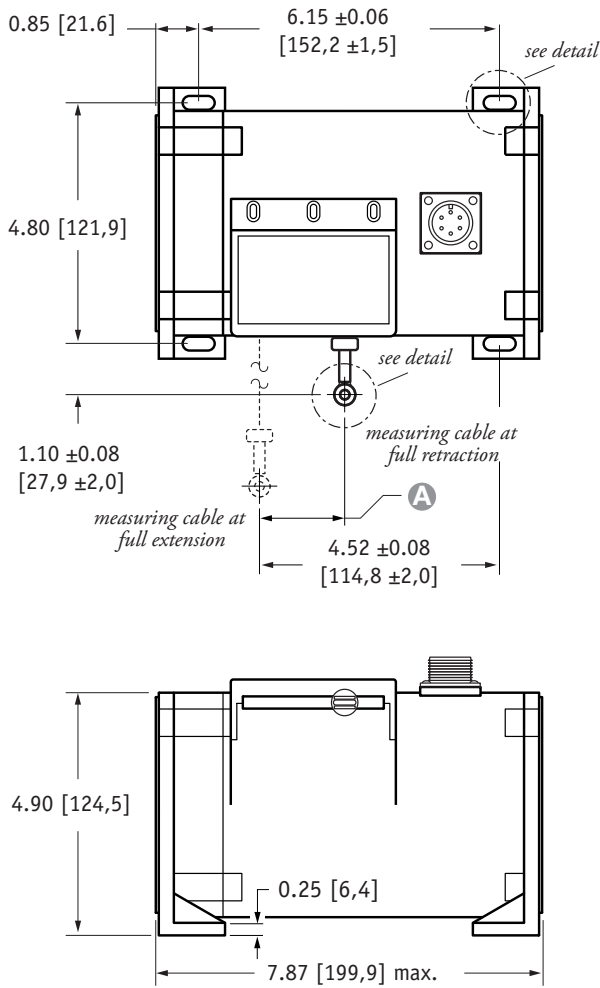

A DIMENSION (INCHES)

RANGE	MEASURING CABLE			
	Ø.031 in.	Ø.034 in.	Ø.047 in.	Ø.062 in.
75	n/a	0.22	0.29	0.37
100	n/a	0.29	0.39	0.49
150	n/a	0.44	0.59	0.73
200	n/a	0.58	0.79	0.98
250	n/a	0.73	0.98	1.22
300	n/a	0.88	1.18	1.47
350	n/a	1.02	1.38	1.71
400	n/a	1.17	1.57	1.96
450	n/a	1.31	1.77	n/a
500	n/a	1.46	1.97	n/a
550	1.61	1.61	n/a	n/a

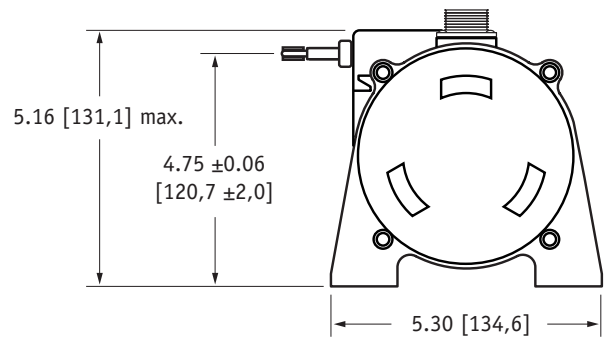

DIMENSIONS ARE IN INCHES [MM]
tolerances are 0.03 IN. [0.5 MM] unless otherwise noted.

* tolerance = +.005 -.001 [+,.13 -.03]
** tolerance = +.005 -.005 [+,.13 -.13]

Ordering Information:

Model Number:

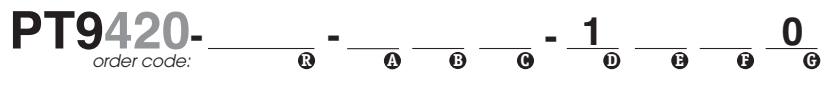

Sample Model Number:

PT9420 - 0500 - 111 - 1110

- R** range: 500 inches
- A** enclosure/cable tension: aluminum/18 oz.
- B** measuring cable: .034 nylon-coated stainless front
- C** cable exit:
- E** output signal: 4...20 mA, 2-wire
- F** electrical connection: 6-pin plastic connector

Full Stroke Range:

R order code:	0075	0100	0150	0200	0250	0300	0350	0400	0450*	0500*	0550*
full stroke range, min:	75 in.	100 in.	150 in.	200 in.	250 in.	300 in.	350 in.	400 in.	450 in.	500 in.	550 in.

* - 36 oz. cable tension strongly recommended

Ordering Information (cont.):

Enclosure Material and Measuring Cable Tension:

Ⓐ order code:	1	3	2	4
tension (±30%):	18 oz.		36 oz.	
enclosure material:	powder-painted aluminum	303 stainless steel	powder-painted aluminum	303 stainless steel
max. acceleration:	1 G	.33 G	5 G	2 G
max. velocity:	60 inches/sec	20 inches/sec	200 inches/sec	80 inches/sec

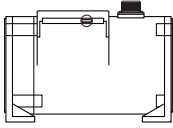
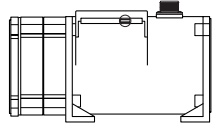
	standard housing see fig 1.		dual-spring housing see fig 2.
---	--------------------------------	---	-----------------------------------





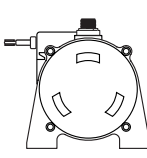
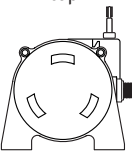
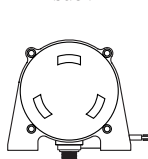
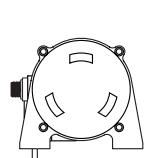

Measuring Cable:

Ⓑ order code:	1	2	3	4
	∅.034-inch nylon-coated stainless steel	∅.047-inch stainless steel	∅.062-inch thermoplastic	∅.031-inch stainless steel
	available in all ranges	all ranges up to 500 inches	all ranges up to 400 inches	550 inch range only

Cable Exit:

Ⓒ order code:	1	2	3	4
	front	top	back	down
				

Output Signals:

Ⓓ order code:	1	2	3	4	5*	6*
output signal options:	4...20 mA 	20...4 mA 	0...20 mA 	20...0 mA 	4...20 mA 	20...4 mA 
sensitivity:	16 mA/full stroke ±0.25%		20 mA/full stroke ±0.25%		16 mA/full stroke ±0.25%	
wiring configuration:	2 – wire		3 – wire		2 – wire	
input voltage:	8 – 34 vdc		14 – 29 vdc		14 – 32 vdc	
hazardous area certification:	not certified		not certified		CSA • Cenelec	

Output Signal Example:

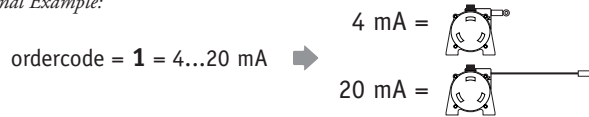

Hazardous Area Certifications:

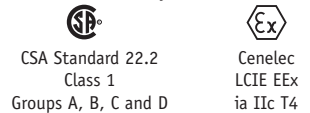

***IMPORTANT:** intrinsically safe when powered from a CSA certified zener barrier rated 28 VDC max, 110 mA max per installation drawing#677984

Ordering Information (cont.):

Electrical Connection:

1 order code:

1
6-pin plastic connector w/mating plug
IP 67, NEMA 4X**,6

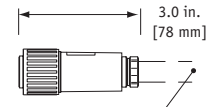

1/2 - 5/16" [14 - 8 mm] cable dia.
16 AWG max conductor size
connector: MS3102E-14S-6P
mating plug: MS3106E-14S-6S

2

10-ft. [3 M]
waterproof cable
IP 67, NEMA 4X**, 6

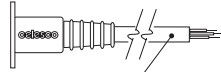

10 ft. x 0.4-in. dia.
[3 M x 10 mm dia.]
18 AWG, type SJTW

3

6-pin metal connector w/mating plug
IP 65, NEMA 4

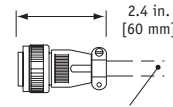

3/8-in. [9 mm] max cable dia.
16 AWG max conductor size
connector: MS3102E-14S-6P
mating plug: MS3106E-14S-6S

4

25-ft. [7.5 M]
instrumentation cable
IP 67, NEMA 6

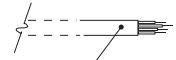

25 ft. x 0.2-in. dia.
[7.5 M x 5 mm dia.]
24 AWG, shielded

5 order code:

5
100-ft. [30 M]
waterproof cable
IP 67, NEMA 4X**,6

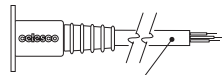

100 ft. x 0.4-in. dia.
[30 M x 10 mm dia.]
18 AWG, type SJTW

6

6
10-ft. [3 M]
pressure tested*
waterproof cable
IP 68, NEMA 4X**, 6P

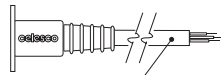

10 ft. x 0.4-in. dia.
[3 M x 10 mm dia.]
18 AWG, type SJTW

7

7
100-ft. [30 M]
pressure tested*
waterproof cable
IP 68, NEMA 4X**, 6P

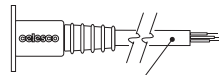

100 ft. x 0.4-in. dia.
[30 M x 10 mm dia.]
18 AWG, type SJTW

6-pin Mating Plug

pin	2-wire	3-wire
A	8...34 vdc***	14...29 vdc common
B	4...20 mA out	0...20 mA out
C	-	-
D	case ground	-

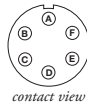

contact view

Waterproof Cable

color code	2-wire	3-wire
WHITE	8...34 vdc***	14...29 vdc common
BLACK	4...20 mA out	0...20 mA out
GREEN	case ground	-

Instrumentation Cable

color code	2-wire	3-wire
RED	8...34 vdc***	14...29 vdc common
BLACK	4...20 mA out	n/a
WHITE	n/a	n/a
GREEN	case ground	0...20 mA out

Notes: { * -Test pressure: 100 feet [30 meters] H₂O (40 PSID); Test Medium: Air; Duration: 2 hours.
** -NEMA 4X applies to stainless steel enclosure only.
*** -14-32 VDC for hazardous area option.

Output Signal Selection (not available with intrinsically safe option):

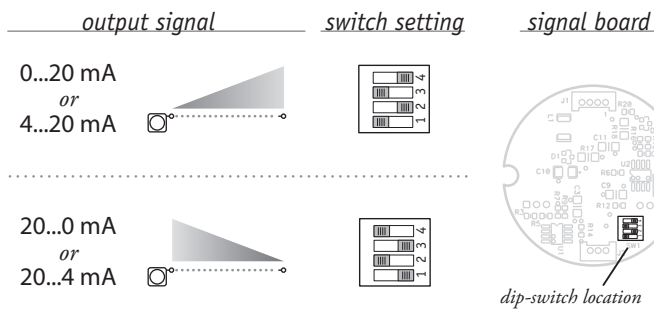

To gain access to the signal board, remove four Allen-Head Screws and remove end cover bracket.

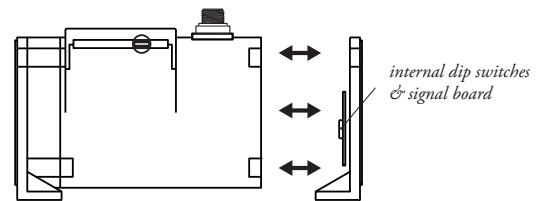

The output signal direction can be reversed at any time by simply changing the dip-switch settings found on the internal signal board. After the settings have been changed, adjustment of the Zero and Span trimpots will be required to precisely match signal values to the beginning and end points of the stroke.

Caution! Do Not Remove Spring-Side End Cover
Removing spring-side end cover could cause spring to become unseated and permanently damaged.

Fig. 2 – Outline Drawing (36 oz. cable tension only)

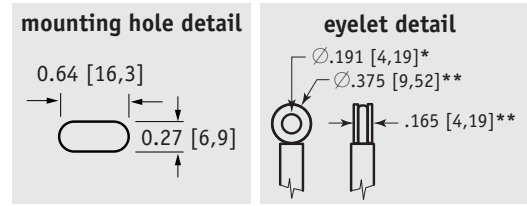
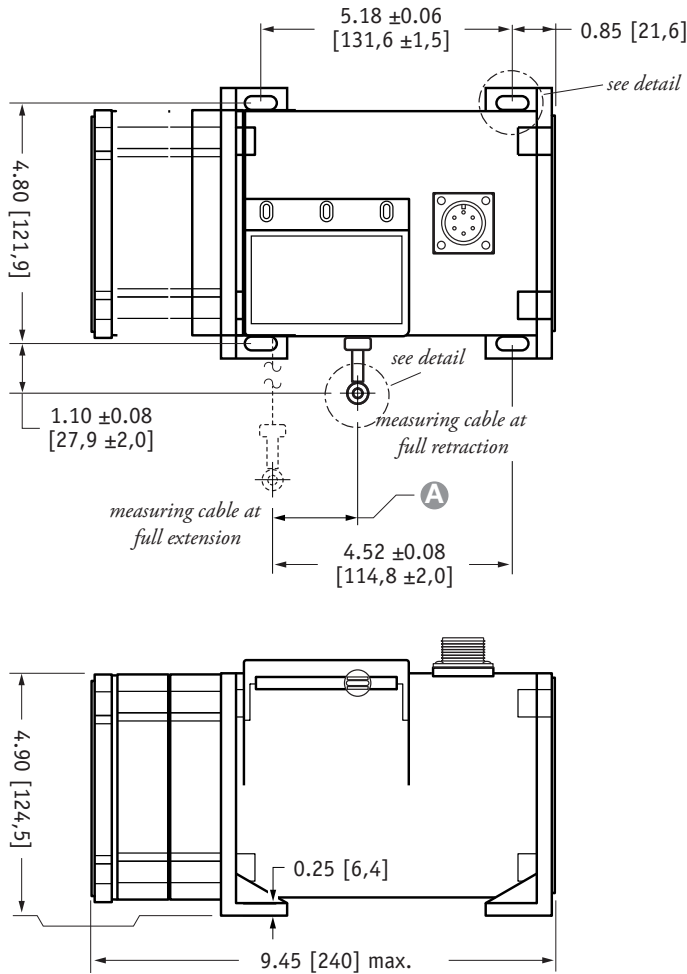

A DIMENSION (INCHES)

RANGE	MEASURING CABLE			
	Ø.031 in.	Ø.034 in.	Ø.047 in.	Ø.062 in.
75	n/a	0.22	0.29	0.37
100	n/a	0.29	0.39	0.49
150	n/a	0.44	0.59	0.73
200	n/a	0.58	0.79	0.98
250	n/a	0.73	0.98	1.22
300	n/a	0.88	1.18	1.47
350	n/a	1.02	1.38	1.71
400	n/a	1.17	1.57	1.96
450	n/a	1.31	1.77	n/a
500	n/a	1.46	1.97	n/a
550	1.61	1.61	n/a	n/a

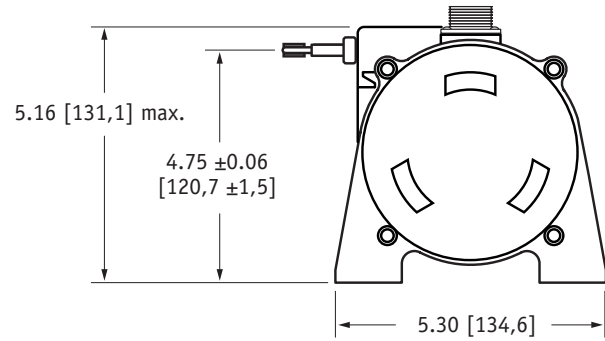

DIMENSIONS ARE IN INCHES [MM]
tolerances are 0.03 IN. [0.5 MM] unless otherwise noted.

* tolerance = +.005 –.001 [+0.13 –.03]
** tolerance = +.005 –.005 [+0.13 –.13]

VLS Option - Free Release Protection

The patented Celesco Velocity Limiting System (VLS) is an option for PT9000 Series cable extension transducers that limits cable retraction to a safe 40 to 55 inches per second for the single spring option and 40 to 80 inches per second for the higher tension dual spring option.

The VLS option prevents the measuring cable from ever reaching a damaging velocity during an accidental free release. This option is ideal for mobile applications that require frequent cable disconnection and reconnection. It prevents expensive unscheduled downtime due to accidental cable mishandling or attachment failure.

How To Configure Model Number for VLS Option:

VLS 9420 - _____ **R** _____ **A** _____ **B** _____ **C** _____ **D** _____ **E** _____ **F** _____ **G**

creating VLS model number (example)...

1. select PT9420 model **PT9420-0100-111-1110**
2. remove "PT" from the model number ~~PT~~ **9420-0100-111-1110**
3. add "VLS" **VLS + 9420-0100-111-1110**
4. completed model number! **VLS9420-0100-111-1110**

version: 11.0 last updated: August 15, 2013