

# Rotational Position Transducer

DeviceNET®

Ranges: 0-90° to 0-50 Turns

Industrial Grade

# RT9DN

## Specification Summary:

### GENERAL

Full Stroke Ranges ..... 0-0.25 to 0-50 turns  
 Electrical Interface ..... CANbus ISO 11898  
 Protocol ..... DeviceNet Version 2.0  
 Accuracy ..... ± 0.30 to 0.15% full stroke  
 Repeatability ..... ± 0.02% full stroke  
 Resolution ..... ± 0.003% full stroke  
 Enclosure Material ..... powder-painted aluminum or stainless steel  
 Sensor ..... plastic-hybrid precision potentiometer  
 Shaft Loading ..... up to 35 lbs. radial and 5 lbs. axial  
 Weight, Aluminum (Stainless Steel) Enclosure ..... 5 lbs. (10 lbs.), max.

### ELECTRICAL

Input Voltage ..... Bus Powered  
 Input Current ..... 40 mA  
 Address Setting (Node ID) ..... 0..63 set via DIP Switches—*default setting: 63*  
 Baud Rate ..... 125K, 250K or 500K set via DIP Switches  
 EDS file ..... available @ <http://www.celesco.com/download>

### ENVIRONMENTAL

Environmental Suitability ..... NEMA 4/4X/6, IP67/68  
 Operating Temperature ..... -40° to 200°F  
 Vibration ..... up to 10 G's to 2000 Hz maximum

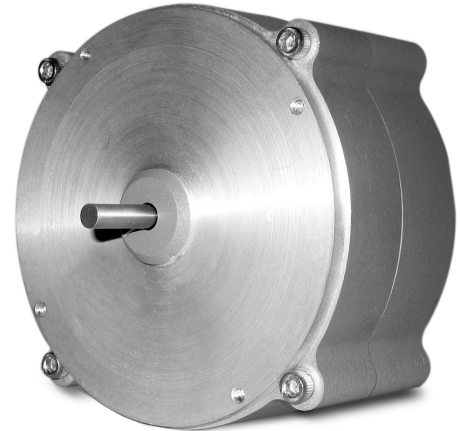

Celesco's model RT9DN communicates rotational position feedback via DeviceNET® to your programmable controller. The heart of this sensor is a precision plastic-hybrid position potentiometer which provides a "absolute" position and does not ever have to be reset to a "home" position after a power loss or planned shutdown.

This innovative sensor from Celesco, designed to meet tough NEMA-4 and IP67 environmental standards, is available in full-stroke measurement ranges of 1/4 to 50 turns.

### Outline Drawing

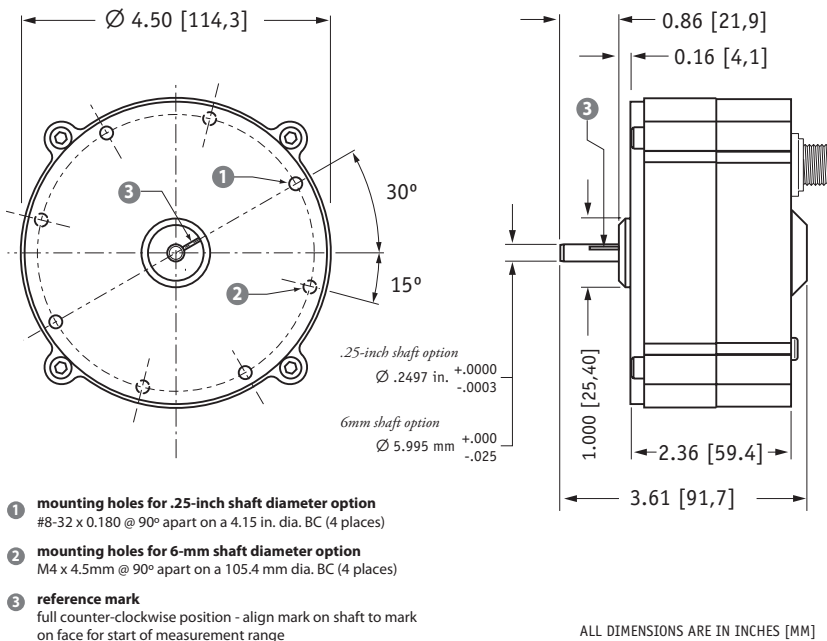

### Output Signal

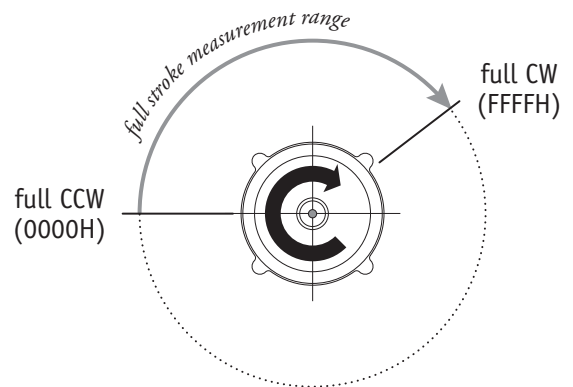

**celesco**

[celesco.com](http://celesco.com) • [info@celesco.com](mailto:info@celesco.com)

Celesco Transducer Products, Inc.  
 20630 Plummer Street • Chatsworth, CA 91311

tel: 800.423.5483 • +1.818.701.2750 • fax: +1.818.701.2799

**I/O Format:**

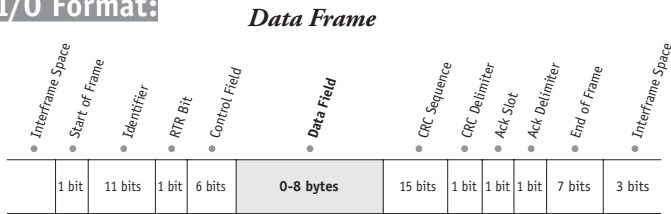

**Data Field**

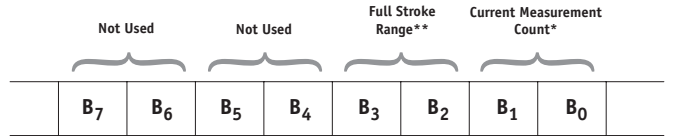

**\*Current Measurement Count**

The **Current Measurement Count (CMC)** is the output data that indicates the present position of the measuring cable.

The CMC is a 16-bit value that occupies the first two bytes (B<sub>0</sub> and B<sub>1</sub>) of the data field. B<sub>0</sub> is the LSB (least significant byte) and B<sub>1</sub> is the MSB (most significant byte).

The CMC starts at 0000H with shaft at the full counter-clockwise position (0° reference mark) and continues in the clockwise direction to the end of the stroke range stopping at FFFFH. This holds true for all ranges.

**\*\*Full Stroke Range**

The **Full Stroke Range (FSR)** is a 16-bit value in the data field that expresses the full range of the sensor in degrees. This value can be used to convert the actual count to units of measurement should the application require it.

The full stroke measurement range occupies the second two bytes (B<sub>2</sub> and B<sub>3</sub>) of the data field.

B<sub>2</sub> is the LSB (least significant byte) and B<sub>3</sub> is the MSB (most significant byte).

This value is expressed in degrees.

Example:

Hex Value	Decimal Equivalent	Full Stroke Range
0168	360	360 degrees

**Converting CMC to Degrees**

If required, the CMC can easily be converted to a rotational measurement expressed in degrees instead of counts.

This is accomplished by first dividing the CMC by 65,535 (total counts over the range) and then multiplying that value by the FSR:

$$\left( \frac{\text{CMC}}{65,535} \right) \times \text{FSR}$$

Example:

If the full stroke range is **1 turn (360 degrees)** and the current position is **OFF2 Hex (4082 Decimal)** then,

$$\left( \frac{4082}{65,535} \right) \times 360 \text{ deg.} = 22.4 \text{ degrees}$$

**Address Setting (Node ID), Baud Rate and Bus Termination Settings**

**Address Setting (Node ID)**

The Address Setting (Node ID) is set via 6 switches located on the 8-pole DIP switch found on the DeviceNET controller board located inside the transducer.

The DIP switch settings are binary starting with switch number 1 (= 2<sup>0</sup>) and ending with switch number 6 (= 2<sup>5</sup>).

DIP-1 (2 <sup>0</sup> )	DIP-2 (2 <sup>1</sup> )	DIP-3 (2 <sup>2</sup> )	DIP-4 (2 <sup>3</sup> )	DIP-5 (2 <sup>4</sup> )	DIP-6 (2 <sup>5</sup> )	address (decimal)
0	0	0	0	0	0	0
1	0	0	0	0	0	1
0	1	0	0	0	0	2
...	...	...	...	...	...	...
1	1	1	1	1	1	63



**Baud Rate**

The transmission baud rate may be either factory preset at the time of order or set manually at the time of installation.

The baud rate can be set using switches 7 & 8 on the 8-pole DIP switch found on the DeviceNET controller board located inside the transducer.

DIP-7	DIP-8	baud rate
0	0	125k
1	0	250k
0	1	500k
1	1	125k



**Bus Termination**

The setting of the internal bus termination resistor may be specified upon order or manually changed by the end user at the time of installation.

The bus termination resistor is activated setting switches 1 & 2 on the 2-pole DIP switch (located on the internal DeviceNET controller board) to the "ON" position.

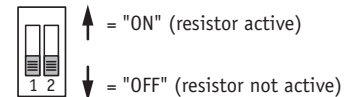

**DeviceNET Controller Board and DIP Switch Location**

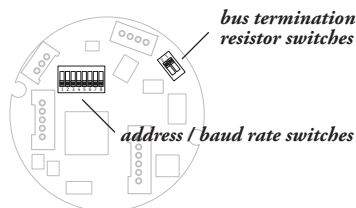

to gain access to the controller board, remove four Allen-Head Screws and separate case halves

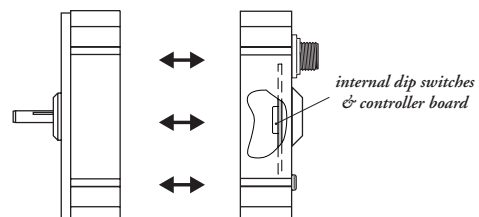

**Ordering Information:**

**Model Number:**

**RT9DN** -      -      -      -      -      -      -       
*order code:*      **R**      **A**      **B**      **C**      **D**      **E**

Sample Model Number:

**RT9DN - 30 - AL - 25 - 500 - TR - SC5**

- R** range: 30 turns
- A** enclosure: powder-painted aluminum
- B** shaft: .25-in diameter
- C** baud rate: 500 k bits/sec.
- D** terminating resistor: yes
- E** electrical termination: 5-meter cordset with straight plug

**Full Stroke Range:**





<b>R</b> <i>order code:</i>	<b>R25</b>	<b>R50</b>	<b>1</b>	<b>2</b>	<b>3</b>	<b>5</b>	<b>10</b>	<b>20</b>	<b>30</b>	<b>50</b>
clockwise shaft rotations, min:	0.25	0.50	1	2	3	5	10	20	30	50
accuracy (% of f.s.):	0.3%	0.3%	0.3%	0.3%	0.3%	0.2%	0.15%	0.15%	0.15%	0.15%
potentiometer cycle life*:	$2.5 \times 10^6$	$2.5 \times 10^6$	$2.5 \times 10^6$	$2.5 \times 10^6$	$2.5 \times 10^6$	$5 \times 10^5$	$2.5 \times 10^5$	$2.5 \times 10^5$	$2.5 \times 10^5$	$2.5 \times 10^5$

\*—number of times the sensor shaft can be cycled back and forth from beginning to end and back to the beginning before any measurable signal degradation may occur.

**Enclosure Material:**

<b>A</b> <i>order code:</i>	<b>AL</b>	<b>SS</b>
	powder-painted aluminum	303 stainless steel

**Shaft Diameter:**

<b>B</b> <i>order code:</i>	<b>25</b>	<b>6</b>	<b>25F</b>	<b>6F</b>
	0.25-in. diameter	6 mm diameter	0.25-in. dia. w/flats	6 mm dia. w/flats
				
	.2497 in. (+.0000 - .0003)	5.995 mm (+.000 - .025)	0.33 in.      0.025 in.	8.4 mm      0.64 mm

**Baud Rate:**

<b>C</b> <i>order code:</i>	<b>125</b>	<b>250</b>	<b>500</b>
	125 kbaud	250 kbaud	500 kbaud

**Terminating Resistor:**

<b>D</b> <i>order code:</i>	<b>TR</b>	<b>NR</b>
	terminating resistor	no terminating resistor

**Ordering Information:**

**Electrical Connection:**

**ⓑ** *order code:*

**blank**

5-pin micro-connector  
*(no mating plug supplied)*

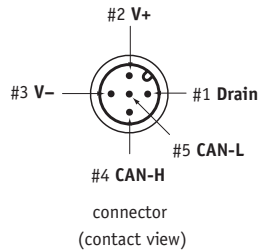

**MC5**

5-pin micro-connector  
w/ mating plug

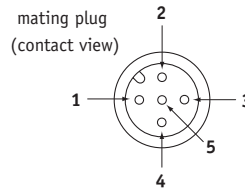
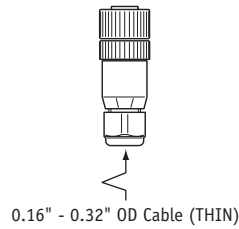

**SC5**

5-pin micro-connector  
and 5 meter length cordset  
w/straight mating plug

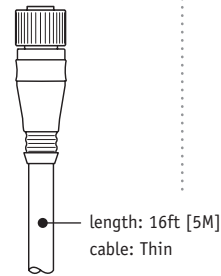

**NC5**

5-pin micro-connector  
and 5 meter length cordset  
w/90° mating plug

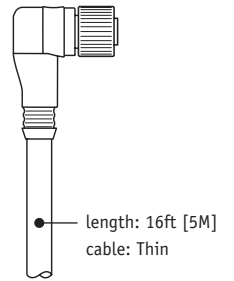

pin	signal	wire color
1	drain	brown
2	V+	white
3	V-	blue
4	Can-H	black
5	Can-L	grey